



GLOBAL supplies & engineering ltd

Thank you for the opportunity to quote on your machine knife requirements.

Please complete and submit the following information to enable us to complete your quotation.

Name:

Title:

Company:

Address:

Phone:

Fax:

Email:

How would you like to be contacted: Phone Fax Email

Specification-

Machine Manufacturer:

Model # (if known):

Current Machine Knife Supplier:

Material being processed-

Ferrous:

Non-Ferrous:

Rubber:

Plastic:

Wood:

Cable:

Green Waste:

Other, please state:



Edge Profile

Choose an Edge Profile

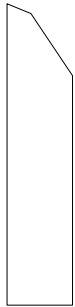

High Shear Double Angle

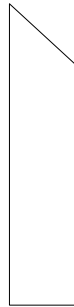

Keen Edge



Reverse Bevel



Hook Knife



Square Edge

High Shear Double Angle

Keen Edge

Reverse Bevel

Hook Knife

Square Edge

HOLE GEOMETRY:

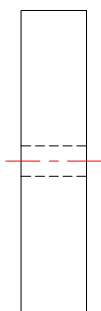

Through Hole

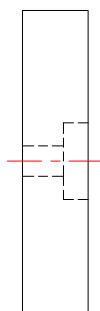

Through Hole with Counter Bore

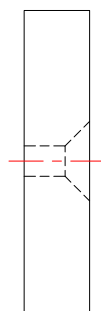

Through Hole with Counter Sink



Knife Blade With Draw Back Hole

Through Hole

Through Hole with Counter Bore

Through Hole with Counter Sink

Knife Blade with Draw Back Hole



ROTOR KNIFE DIMENSIONS:

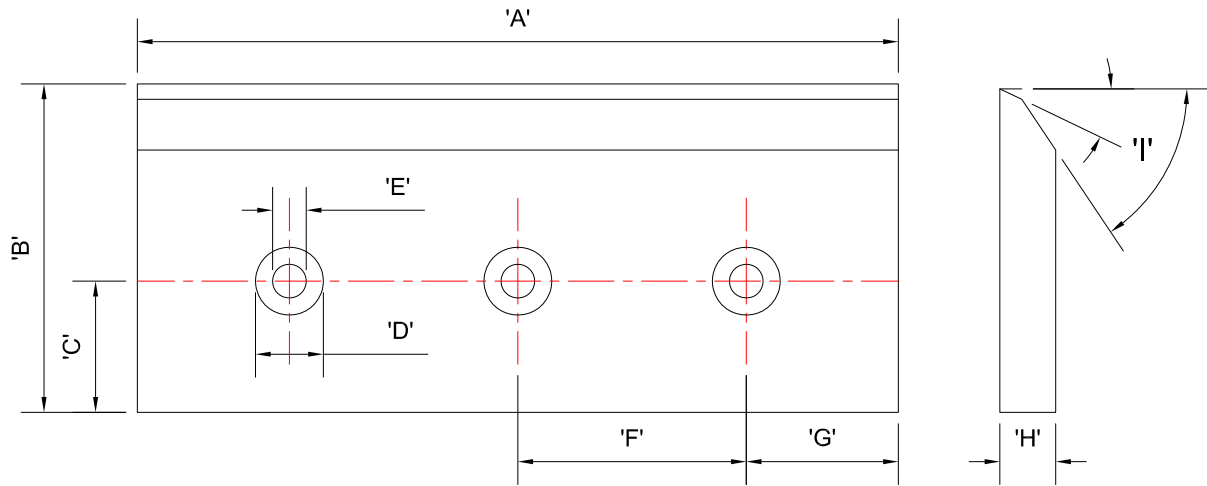

Are knives being measured: New Used

A (Length)

B (Height)

C (Heel to Hole)

Holes

D (Thru-Hole Diam)

E (Counter Sink/Bore Dim)

F (Hole to Hole)

G (Edge to Hole)

H (Thickness)

I 1 (Primary Angle(s))

I 2 (Secondary Angle(s))

Rotor Knife Quantity/Set:

Rotor Knife Sets Required:

Target Price Per Blade:



BED KNIFE DIMENSIONS:

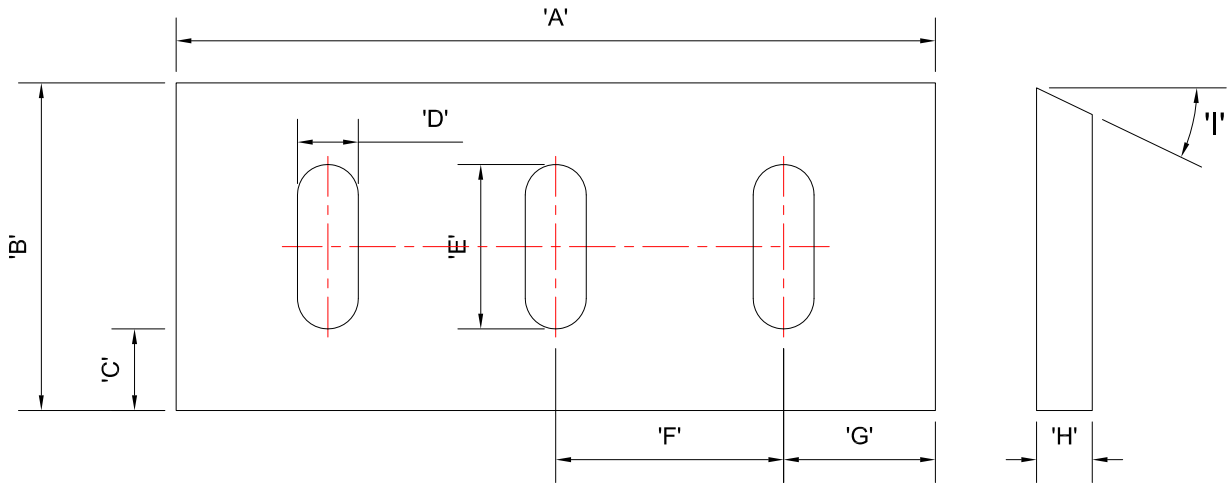

Are knives being measured: New Used

- A (Length)
- B (Height)
- C (Heel to Slot)
- # Slots
- D (Slot Diameter)
- E (Slot Length)
- F (Slot to Slot)
- G (Edge to Slot)
- H (Thickness)
- I (Angle)

Bed Knife Quantity/Set:

Bed Knife Sets Required:

Target Price Per Blade: